

HEWLETT-PACKARD JOURNAL

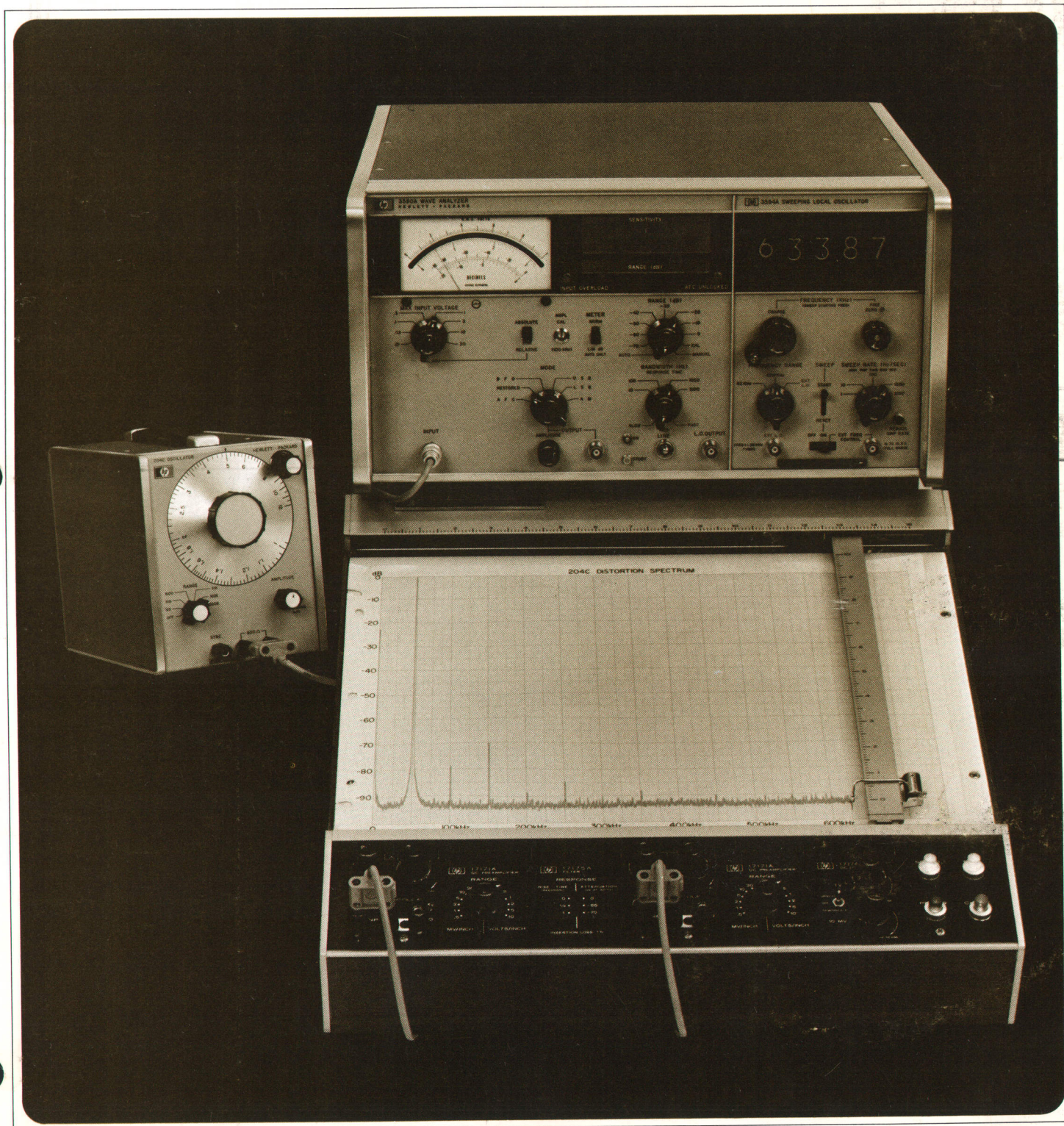

DECEMBER 1968

Rapid Analysis of Low Frequency Spectra

Detection of signal amplitude and frequency is made easier with automatic amplitude ranging and electronic sweeping.

By Larry A. Whatley

IN MANY WAVE AND SPECTRUM ANALYSIS APPLICATIONS, it is desirable to display frequency vs. amplitude linearly on two axes. Harmonics of a pulse train plotted this way (Fig. 1A) show the $(\sin x)/x$ distribution. When analyzing a signal whose harmonics are much smaller than the fundamental, a plot representing amplitude logarithmically is most useful (Fig. 1B).

Wave analyzers are also used to determine system frequency response. Many analyzers have a 'tracking' or 'BFO' signal output whose frequency lies within the pass-band wherever the analyzer may be tuned. This tracking oscillator output may be used to drive a system while the system output is measured by the analyzer, providing information to construct a Bode plot. The conventional display for this application (Fig. 1C) is plotted on two log-

arithmic axes to offer easier readability over the wide range of amplitudes and frequencies involved. When analyzing signals containing low-frequency components, a wave analyzer with narrow bandwidths and slow sweep rates must be used. A high resolution analysis may require several minutes to complete. Here the X-Y recorder offers a large and permanent record.

In addition to the more traditional applications of waveform analysis, a new sweeping wave analyzer (Fig. 2) now offers a unique capability in analysis of complex frequency spectra. High resolution plots of spectral components over a 90 dB display range, Fig. 3, can be made using the new HP Model 3590A Wave Analyzer and a companion X-Y recorder. Automatic amplitude ranging and electronic sweep operation, integral to the Model 3590A, allow high performance in spectrum analysis applications from 20 Hz to 620 kHz while retaining the large dynamic range and frequency accuracy expected in a wave analyzer. The frequency and amplitude axes of a spectral plot may be chosen to be either linear or logarithmic, in any combination, yielding appropriate displays for a variety of applications.

Sweeping Local Oscillator

It is important for sweeping that the sweep be very linear and easy to set up and calibrate. Traditionally, variable air capacitors have been used to tune a wave analyzer local oscillator. Cumbersome mechanical drives

Cover: *Low distortion of the HP Model 204C Oscillator, measured by the HP Model 3590A Wave Analyzer, is displayed over a 90 dB range on an HP Model 7004A X-Y Recorder.*

In this Issue: *Rapid Analysis of Low Frequency Spectra; page 2. High Dynamic Performance X-Y Recorder; page 8. A Low-Cost, General Purpose Oscillator, page 12. Amplitude Stability with a Zener Level Detector, page 14.*

have been used to obtain sweep frequency tuning. Now, varactors can be used to tune local oscillators, and suitable shaping of the controlling voltage obtains the requisite linearity. Electrical control of oscillator tuning in the Model 3590A not only simplifies sweep frequency tuning arrangements, but also allows external electrical control of the wave analyzer tuning.

The oscillator must have good short-term stability as well as long-term stability. Oscillator deviations of only a few Hz can shift the passband an equal amount. This would cause the signal to fall outside the passband when using such narrow bandwidths as the 10 Hz choice offered by this analyzer.

Two requirements are very difficult to satisfy simultaneously—stability and linearity. Good stability suggests use of a mechanically tuned L-C oscillator, while good frequency linearity is generally obtained with a multivibrator type circuit. Neither oscillator type solves both requirements, so a more sophisticated system is used (Fig. 4). The basic oscillator is an L-C type using a varactor diode whose capacitance is a function of voltage. This function is non-linear, and since the oscillation frequency depends upon the value \sqrt{LC} , the overall relation between frequency and voltage is not simple. The frequency can be made a linear function of voltage, however, by passing the control voltage through a special non-linear shaping network before applying it to the varactor. The shaping network uses 10 linear segments to yield overall linearity within 1%. Long-term stability is achieved by enclosing the necessary circuitry within a temperature-controlled oven.

Second Tuning Range

Measurements in the audio frequency range using a very narrow passband require high stability. The HP Model 3590A generates the LO signal in a way that reduces the normal 620 kHz tuning range to 62 kHz. This spreads the tuning range so that the frequency control changes the frequency only 1/10 as much as on the 620 kHz range. Resolution of the frequency readout is also increased an order of magnitude. But the most significant advantage is that frequency stability is increased tenfold.

In the 62 kHz mode the basic LO (Fig. 4) is used just as it is in the 620 kHz mode. Rather than use this frequency directly as the local oscillator source, however, it is divided by ten and mixed with a fixed frequency to yield a product covering a range from 1.28 to 1.342 MHz as the LO is tuned from 1.28 to 1.90 MHz. This smaller tuning range is used as the LO signal, mixing input signals

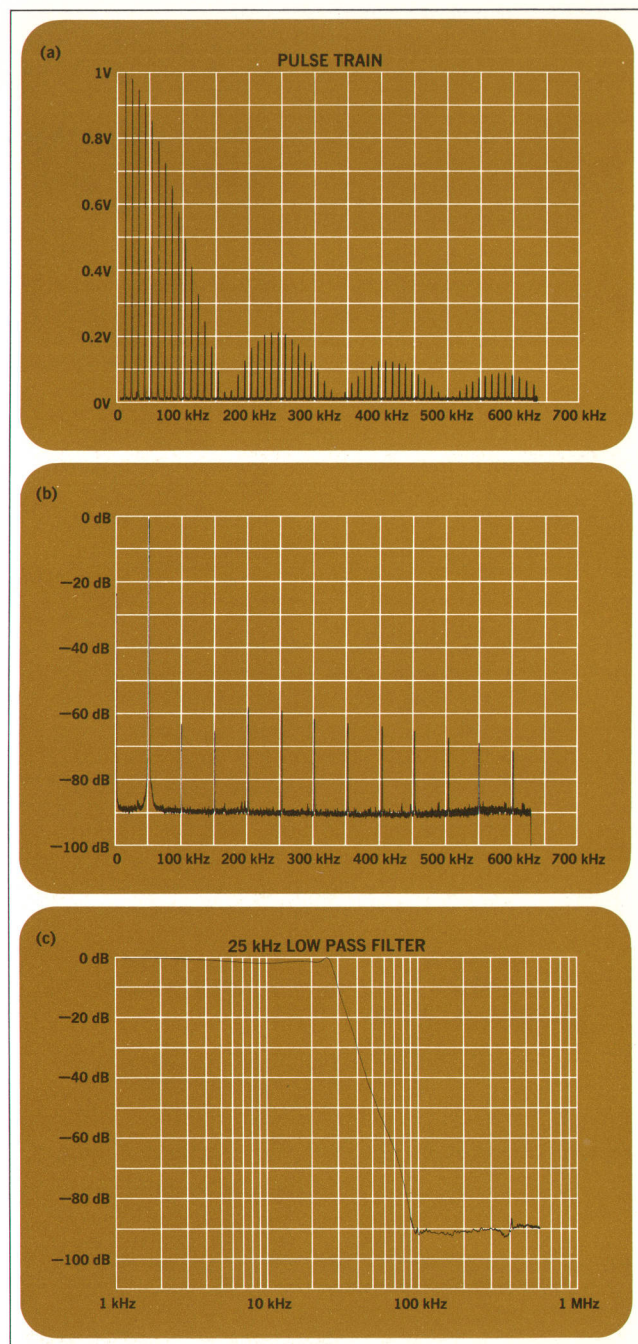

Fig. 1. The frequency spectrum of a pulse train plotted on linear axes (A) clearly show the $\sin x/x$ envelope of the fundamental and harmonics. Harmonic components of a 50 kHz sine wave (B) are displayed very clearly on a logarithmic amplitude scale and a linear frequency scale. Plotting the frequency response of a filter on two logarithmic axes (C) gives good resolution at both extremes of amplitude and frequency.

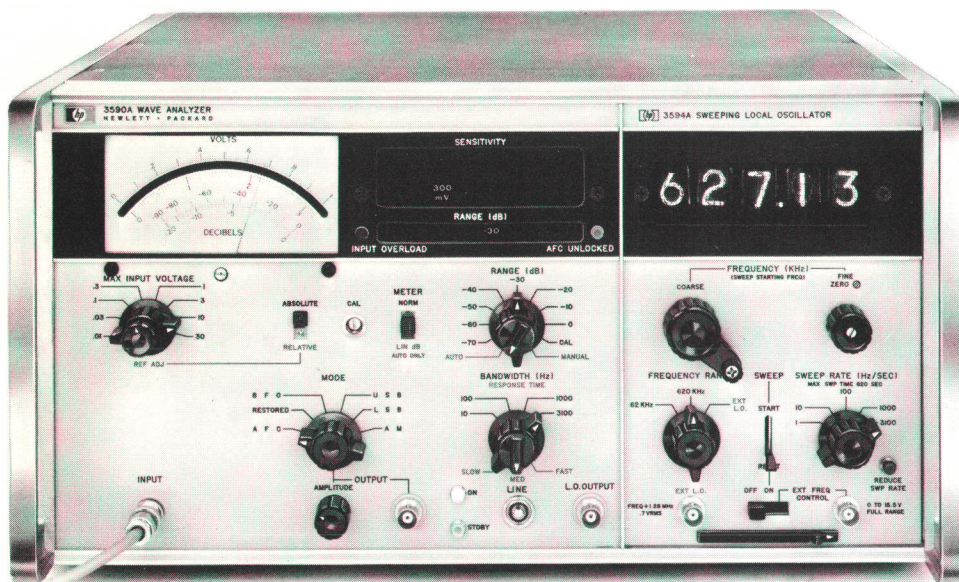

Fig. 2. This new HP Model 3590A Wave Analyzer makes selective measurements from 20 Hz to 620 kHz over an 85 dB dynamic amplitude range. Automatic amplitude ranging, internal electronic sweep, lighted meter scales and both log and linear X-Y recorder outputs are included.

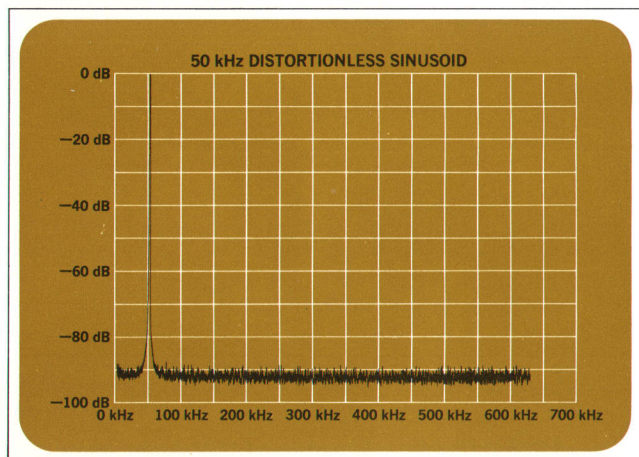

Fig. 3. Measuring a pure 50 kHz sinusoid demonstrates that the Model 3590A typically contributes no spurious or distortion products to the frequency spectrum.

between 0 (theoretically) and 62 kHz resulting in an IF of 1.28 MHz when the LO is properly tuned. The result is frequency stability of a high order for the critical low-frequency application using the 10 Hz bandwidth. For applications requiring the wider tuning range, the 100, 1000 and 3100 Hz bandwidths may be used from as low as 200 Hz up to 620 kHz. For measurements requiring precise frequency readout, the Model 3594A local oscillator plug-in has a 5-digit frequency display, and the Model 3593 plug-in has a conventional 3-digit readout with 1% accuracy.

FET Input Amplifier

The ultimate sensitivity of the instrument is determined by the input amplifier noise level and the bandwidth. The difference between the noise level and the amplifier maximum undistorted signal output limits the dynamic range. With the use of FET circuitry in the Model 3590A, the full 85 dB dynamic range can be used with the 0 dB reference set as low as 10 mV. There is a trade-off between input resistance and inherent noise level. A value of 100 k Ω was chosen for the input attenuator on the Model 3590A. This was considered the best compromise.

Active Filters For Selectivity

The selectivity of a wave analyzer is determined by the passband of the IF circuits, just as in a superheterodyne receiver. Crystal filters have commonly been used to establish the passband, but even better passband shaping has been achieved with active filters (Fig. 5). Like the HP Model 310A and 312A Wave Analyzers, the Model 3590A translates the IF down to a 'zero carrier frequency' where audio-frequency active filters can be used to obtain the flat top and steep skirts desired in the filter response. After filtering, the signal is translated back up to the intermediate frequency, then rectified to obtain a voltage to drive the meter.

The passband of the Model 3590A is flat within 1% over at least 50% of the bandwidth, which alleviates tuning difficulties by allowing a little mistuning without

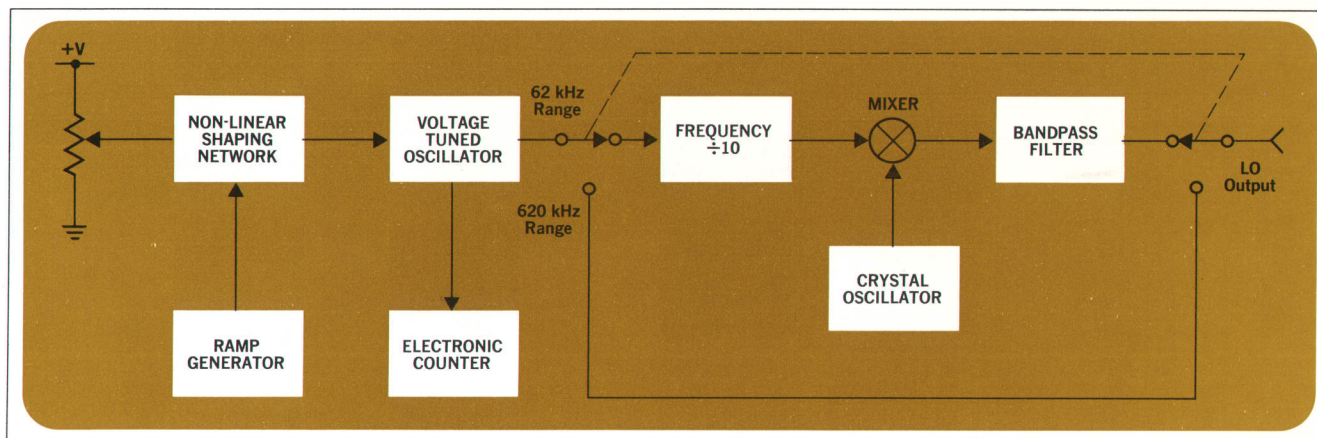

Fig. 4. Tuning circuitry in the Model 3594A Local Oscillator plug-in may be set to cover either a 620 kHz or 62 kHz range. The narrow range offers better accuracy, stability and resolution for those applications not needing the wide range.

loss of amplitude accuracy. The shape factor of the skirts (ratio of bandwidth at -60 dB to bandwidth at -3 dB) is a very low 3.5:1, insuring high rejection of signals only slightly removed from the passband.

90 dB Range Display

The interstage range attenuator, also in the IF circuit, in effect adjusts meter sensitivity to allow high-resolution measurements on low-level frequency components in the presence of large ones.

Components are indicated over a 90 dB range using the front panel meter of the Model 3590A. Indicating this wide amplitude range on the meter or recorder requires a dc voltage proportional to log amplitude. Obtaining a dc voltage linearly proportional to signal amplitude in dB requires a method similar to the mental process we have always used, but now it is done automatically within the instrument. It is a composite measurement traditionally made by observing the setting of an attenuator, and reading a meter usually on a non-linear scale calibrated in dB.

Two corresponding dc levels are required to generate an output scaled in linear dB: (1) a level directly proportional to the setting of the attenuator, and (2) a level proportional to the log of the meter reading (i.e., directly proportional to the metered signal in dB). The algebraic sum of these two levels covers a total range of 90 dB in the new analyzer. The method of obtaining the 90 dB range display is shown in Fig. 6.

The IF signal amplitude may vary up to 90 dB during a sequence of measurements. The purpose of the system, Fig. 6, is to operate on these widely different amplitudes

and deliver a dc output voltage calibrated in decibels: in this case, 0.1 V/dB.

One of the necessary prerequisites is transformation of the dc output of the metering circuit (which is proportional to the IF signal) into a dc level proportional to the log of the signal. The operational amplifier following

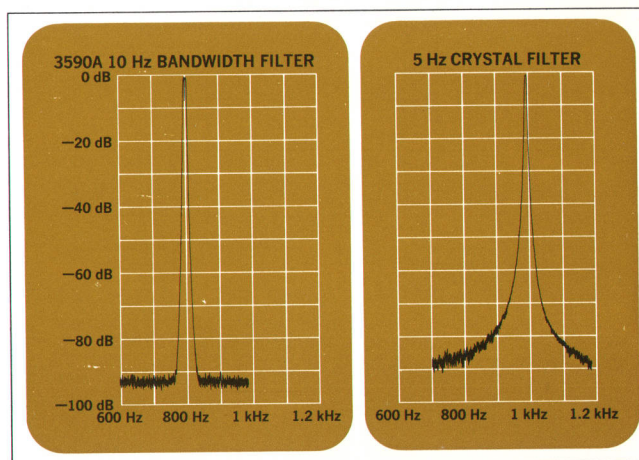

Fig. 5. Comparison of the 10 Hz active bandpass filter in the Model 3590A with a typical crystal filter also designed for wave analysis. While the crystal filter has a narrower bandpass at the 3 dB points, it is broader below 30 dB. The 10 Hz active filter offers more selectivity when measuring small signals adjacent to large signals.

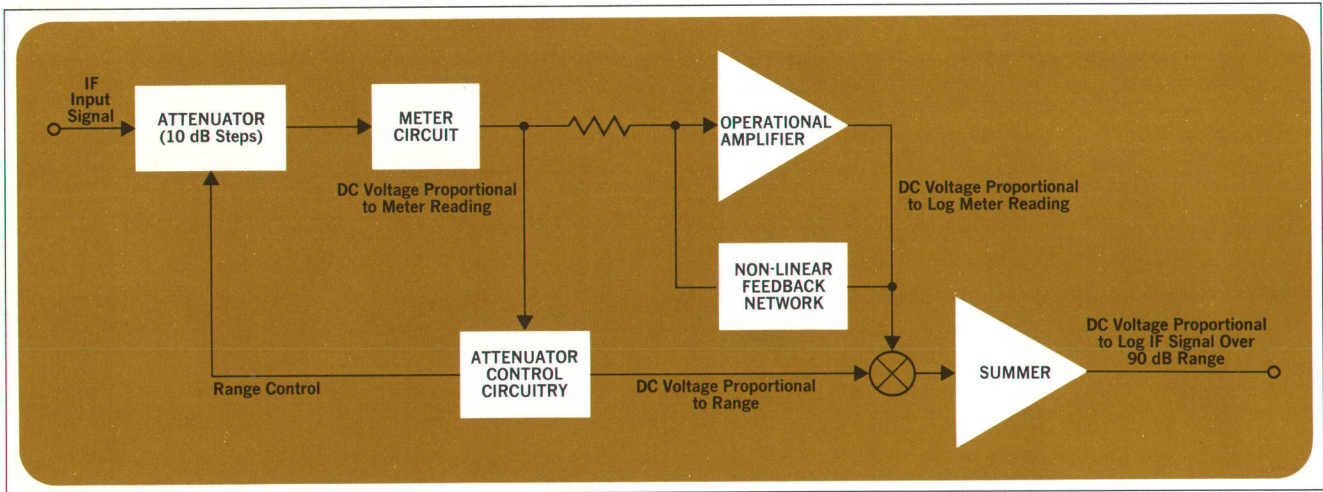
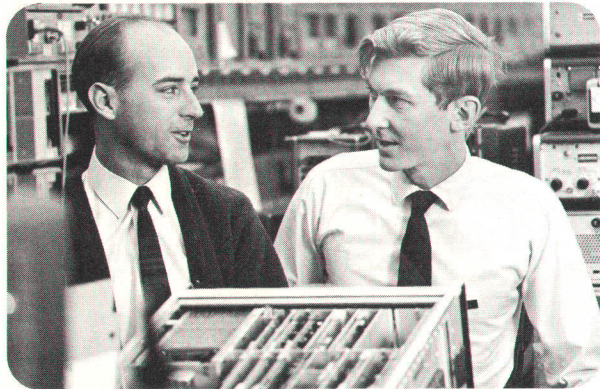

Fig. 6. Metering circuit and logarithmic amplifier. The IF attenuator is set automatically to the proper range. Two dc levels—one proportional to range setting, the other logarithmically proportional to the metered signal—are summed to give an output level logarithmically proportional to the IF signal amplitude, calibrated in volts per dB over a 90 dB display range.



After joining HP in Loveland in 1964, **Larry Whatley** (right) worked on the Model 331 series distortion analyzers. He started on the Model 3590A project at its beginning and became group leader in 1966. He is presently a group leader working on signal generators.

Larry has a BSEE from Oklahoma State University (1961) and received an MS in General Engineering from the same school in 1963. He holds a patent on the auto-nulling technique used in the Models 333A and 334A Distortion Analyzers.

Alfred Gort (left) worked at Hewlett-Packard Laboratories for two years on the investigation and design of optical instrumentation. He joined the design team for the Model 3590A in Loveland in 1965 and worked primarily on plug-in design. Al became project leader on the Model 3590A in its later design stage.

Al completed his undergraduate work at the Technical University of Eindhoven, Netherlands and received an MSEE from California Institute of Technology in 1962. He has done graduate work at Stanford University and Colorado State University under the HP Honors Coop Program.

the meter circuit performs this transformation with a diode feedback network. The resulting transfer function of the operational amplifier is a piece-wise linear approximation of a log response, converting a signal between 1/10 and full-scale meter indication to a dc level within a few percent of the true logarithmic value. Signals from zero to 1/10 full scale are passed through linearly, since zero input voltage would correspond to a negative infinite output voltage on a logarithmic scale.

Autoranging IF Attenuator

The metering circuit and logarithmic amplifier, Fig. 6, work together to generate a dc voltage proportional to the IF input signal in decibels over a 20 dB range for small input levels. To extend this operation to larger levels, the attenuator may be switched to one of its multiples of 10 dB attenuation. For each of these ranges there is a dc voltage available whose amplitude is calibrated to be the equivalent of the log amplifier output. These are the two dc levels which are summed to give a composite level proportional to the input signal over a 90 dB range. The two levels are calibrated so that if the attenuator is advanced 10 dB, one level rises but the other drops by the same amount, the sum remaining the same. The process may be considered as the combination of a dc pedestal, determined by the attenuator setting, with a superimposed dc level, which is continuously variable depending on the input signal level.

For this system to work, the IF attenuator must be set so the signal level at the metering circuit falls within its

dynamic range and also within that of the log amplifier. Manual operation of the attenuator would be bothersome and during frequency swept operation of the analyzer, it would clearly be impossible. The IF attenuator has therefore been made autoranging.

Autoranging is not merely a prerequisite for developing the logarithmic display, however. To find and measure frequency components it has traditionally been necessary to go through several alternate settings and adjustments of the frequency control and IF attenuator range. When the attenuator is properly set automatically, the components may then be identified and measured in rapid succession by adjusting the frequency control only. Now the entire spectrum may be seen by starting the sweep and observing each frequency component as it is crossed.

Balanced Input Circuitry

A different version of the wave analyzer, the 3591A Selective Voltmeter, has balanced input circuitry. There are two input terminals and a ground reference terminal. The inputs are not floating but are separate channels, well matched to give good common mode rejection. Either input terminal may be used separately with single-ended sources or both may be used for differential measurements across balanced sources. The 3591A is cali-

Correction

In our July 1968 issue it was reported that the IEC had changed the designation of the 'N' weighting curve for sound-level meters to 'D' ('IEC Renames Noise Contour,' page 7). This was actually a recommendation of IEC Technical Committee 29. It has not yet been raised to the status of a Recommendation of the IEC.

brated in dBm for several impedances and may be used for either bridged or terminated measurements.

Acknowledgments

Dick Moore was the group leader responsible for the 3590A in its early design phase. Product design of the 3590A, 3593A, and 3594A was done by Darrell Coble and Don Huff. Bob Jeremiasen developed the IF circuitry and then became production engineer responsible for the instrument. The balanced input circuitry of the 3591A was designed and developed by Peter Chu. Dave Lee did development work in several areas including the autoranging circuitry. Bill Beierwaltes developed the BFO and Restored Output circuitry. Don Bloyer designed and developed the illuminated meter case. Bill Nicolay aided in development of the 3593A and 3594A plug-ins. Gerald Reid and Clark Gibson helped in testing and trouble shooting during the final development stages. 

SPECIFICATIONS

HP Model 3590A Wave Analyzer

FREQUENCY RANGE: 20 Hz to 620 kHz.

AMPLITUDE RANGES: 3 μ V to 30 V full scale in 15 ranges.

AMPLITUDE ACCURACY:
Meter switch in normal position
Overall accuracy: ± 0.5 dB or $\pm 5\%$ of reading.
Meter switch in linear dB position
Overall accuracy: ± 1 dB.

INTERNAL LEVEL CALIBRATOR:
Accuracy: ± 0.1 dB.

DYNAMIC RANGE:
IM and harmonic distortion products
>85 dB below zero dB reference level (>70 dB for 20 Hz to 50 Hz).
Residual responses
>80 dB below zero reference (>70 dB for 20 Hz to 50 Hz).

NOISE LEVEL:

Bandwidths	Input Noise Level (600 Ω Source Impedance)
10 Hz and 100 Hz	<0.3 μ V
1 kHz and 3.1 kHz	<1.0 μ V

SELECTIVITY:

Rejection	Bandwidths			
3 dB	10 Hz	100 Hz	1 kHz	3.1 kHz
60 dB	35 Hz	320 Hz	3.1 kHz	9.6 kHz

(Frequency accuracy $\pm 10\%$)

AUTOMATIC FREQUENCY CONTROL:
Dynamic hold-in range: >3 bandwidths.

INPUT IMPEDANCE:
RESISTANCE: 100 k Ω all ranges.
CAPACITANCE: <50 pF for 10 mV, 30 mV, input ranges.
<30 pF for 100 mV to 30 V input ranges.

OUTPUTS:
Restored, BFO, USB, LSB, AM.
Amplitude: Adjustable 0 to 1 V rms open circuit.

LO OUTPUT:
Frequency: 1.28 MHz to 1.90 MHz (1.28 MHz + tuned frequency).

POWER: 115 V or 230 V $\pm 10\%$, 50 Hz to 400 Hz, <70 W, (includes plug-in).

WEIGHT: Net 38 lb (16.8 kg), shipping 47 lb (21.3 kg).

PRICE: HP 3590A, \$3200.00.

3592A Auxiliary Plug-In (For use with external L.O. only)

EXTERNAL L.O. INPUT: 1.28 to 1.90 MHz (1.28 MHz + tuned frequency).

INPUT IMPEDANCE: 10 k Ω in parallel with <120 pF.

NET WEIGHT: 2 lb

PRICE: HP 3592A, \$80.00

3593A Sweeping Local Oscillator

	Frequency Ranges	
	20 Hz to 62 kHz	500 Hz to 620 kHz
Frequency Accuracy:	$\pm(1\% + 20$ Hz) of dial setting	$\pm(1\% + 200$ Hz) of dial setting
Frequency Resolution:	10 Hz/minor div.	100 Hz/minor div.
Ext. Frequency Control:	0 to 15.5 V (250 mV/kHz $\pm 5\%$)	0 to 15.5 V (25 mV/kHz $\pm 5\%$)
Bandwidth Specified:	10, 100, 1000 3100 Hz	100, 1000 3100 Hz

Sweep rates: 1 Hz/s, 10 Hz/s, 100 Hz/s, 1000 Hz/s, 3100 Hz/s.

Sweep linearity: $\pm 1\%$ of final value.

Maximum sweep time: 620 sec $\pm 15\%$.

Start frequency: determine by frequency control setting.

External L.O. input: 1.28 to 1.90 MHz (1.28 MHz + tuned frequency).
Input impedance: 10 k Ω in parallel with <120 pF.

Net Weight: 7.5 lb.

Price: HP 3593A, \$1100.

3594A Sweeping Local Oscillator

	Frequency Range	
	20 Hz to 62 kHz	500 Hz to 620 kHz
Frequency Accuracy:	$\pm(1$ Hz + time base accuracy)	$\pm(10$ Hz + time base accuracy)
Frequency Resolution:	1 Hz	10 Hz
Ext. Frequency Control:	0 to 15.5 V (250 mV/kHz $\pm 2\%$)	0 to 15.5 V (25 mV/kHz $\pm 2\%$)
Bandwidth Specified:	10, 100, 1000 3100 Hz	100, 1000 3100 Hz

Time base accuracy
Temperature coefficient: $+15^\circ$ to $+35^\circ\text{C}$ ± 1 ppm/ $^\circ\text{C}$ ($+25^\circ\text{C}$ ref).
Aging rate: ± 3 ppm per month.

Sweep rates: 1 Hz/s, 10 Hz/s, 100 Hz/s, 1000 Hz/s, 3100 Hz/s.

Sweep linearity: $\pm 1\%$ of final value.

Maximum sweep time: 620 sec $\pm 15\%$.

Start frequency: determined by frequency setting.

External L.O. input: 0.65 V ± 0.2 V rms, 1.28 to 1.90 MHz (1.28 MHz + tuned frequency).
Input impedance: 10 k Ω in parallel with <100 pF.

Net Weight: 7.5 lb.

Price: HP 3594A, \$1600.

MANUFACTURING DIVISION: LOVELAND DIVISION
P. O. Box 301
815 Fourteenth St. S.W.
Loveland, Colorado 80537

High Dynamic Performance X-Y Recorder

Pen acceleration has been made compatible with high slewing speed by use of a direct-coupled servo amplifier and a miniature high-torque dc motor.

By Otto S. Talle Jr.

TWO-AXIS OR X-Y RECORDERS are widely used to record phenomena with respect to time or with respect to other phenomena. X-Y recorders are capable of very accurate plots and facilitate quick interpretation of data. Their static accuracy, that is, the accuracy with which any desired point may be plotted, is generally excellent. Their dynamic performance, the ability to accurately follow a rapidly changing signal, is determined by pen acceleration, pen speed and servo loop gain. It is this dynamic performance that is a limiting factor.

A new X-Y recorder, the HP Model 7004A, Fig. 1, has a pen that is capable of an acceleration in excess of 1200 inches per second or 3G. This is roughly four times better than previous instruments.

Dynamic Performance

Most X-Y recorders have offered maximum pen speeds (slewing speeds) of about 20 in/s. However, their acceleration is in the range of 0.5 to 1G, which is much too low to provide good dynamic performance. Pen acceleration must be compatible with slewing speed. With available acceleration of 1G or less, the recorder will be acceleration limited much more frequently than velocity limited, and in typical dynamic plotting applications will seldom be able to approach its rated slewing speed. For example, consider what happens when a step input is applied to a recorder which has 1G acceleration and 20 in/s slewing speed. The pen will travel about 3 inches before slewing speed is attained.

Dynamic performance of the Model 7004A is illustrated in Fig. 2. Fig. 3 shows typical performance resulting from a step input.

Servo System

The unusual dynamic performance of the Model 7004A results from using a dc-coupled servo amplifier

and a low-inertia dc motor rather than a conventional ac carrier system. The conventional ac carrier type servo amplifier is generally limited to a carrier frequency equal to the power line frequency. Self-contained oscillators producing higher frequencies are usually not practical since they must also furnish high power for the servo motor reference winding. Therefore, the carrier frequency is usually limited to 50 or 60 Hz.

One frequency response limit is the maximum modulation frequency that the servo amplifier will be required to pass. The amplifier response must be substantially flat between $f_c \pm f_m$ where f_c is the carrier frequency and f_m the maximum modulation frequency. The dc-coupled servo amplifier eliminates this limitation on frequency response.

With conventional ac servos slewing speed is related to the power line frequency. Changes in the power line frequency, from 60 to 50 Hz, cause the slewing speed to drop from 20 in/s to 16.7 in/s, further degrading the dynamic performance. With the dc servo amplifier and motor, performance remains constant with power line frequency changes from 50 to 400 Hz.

Servo Motor

The permanent magnet dc servo motor is a key component in this higher performance system. The attribute of main concern is the motor's ability to deliver high torque output from a very low inertia rotor. Rotor inertia is a very significant part of the total inertia load as seen by the motor, and the inertia load, driven by the motor, must be minimized to achieve good acceleration and overshoot characteristics.

Most commercially available dc servo motors are designed for high speed applications such as valve actuators, etc., and they tend to perform poorly at low speed. Typical poor low speed characteristics include high start-

ing voltage and severe cogging (stepping). The new dc servo motor, designed for the Model 7004A, possesses high torque, high acceleration, low starting voltage and is virtually free of low speed cogging.

Plug-ins

In addition to good dynamic performance, the Model 7004A provides operating and application flexibility through the use of input plug-ins. A plug-in scheme was developed that allows (in each axis): (1) The use of a single plug-in; (2) The ability to switch electrically between two single plug-ins; (3) The ability to operate two plug-ins in series; (4) The use of a single double size plug-in. The plug-ins fall into one of three categories:

(1) Signal conditioners, (2) Signal generators, and (3) Controllers.

Plug-ins can be combined to produce three basic types of recorders. A low-cost systems recorder results from the use of the Model 1717A DC Coupler plug-in. A precision laboratory recorder uses the DC Preamplifier, Time Base and DC Offset plug-ins. With the Model 17173A Null Detector and the Model 17012B Point Plotter, the recorder becomes a point plotting system capable of plotting up to 50 points per second.

Functional Blocks

Six basic functional blocks comprise the Model 7004A, Fig. 4. Signal conditioning is needed to attain flexibility in operation and application. The signal conditioning section includes the input terminals, the input plug-in areas, and the module selector switch. The plug-ins act as 'jumpers' between the input terminals and the input to the servo loop, and can be used singly or in series. The resultant output, or output combination, can be selected by the module selector. The basic servo loop sensitivity of the frame is 100 mV/in. Therefore, in many system applications requiring a nominal 1 volt full scale, additional active circuitry in a plug-in is not needed. However, in other applications, a plug-in may be required to amplify, attenuate, or otherwise alter the input signal.

The balance circuit consists primarily of a FET differential amplifier that acts as a comparator between the input signal (provided from the input plug-ins) and the position feedback voltage provided by the servo driven slidewire. When the position feedback voltage equals the input voltage, the output (error) voltage from the comparator, and therefore from the servo amplifier, becomes zero and the servo motor stops.

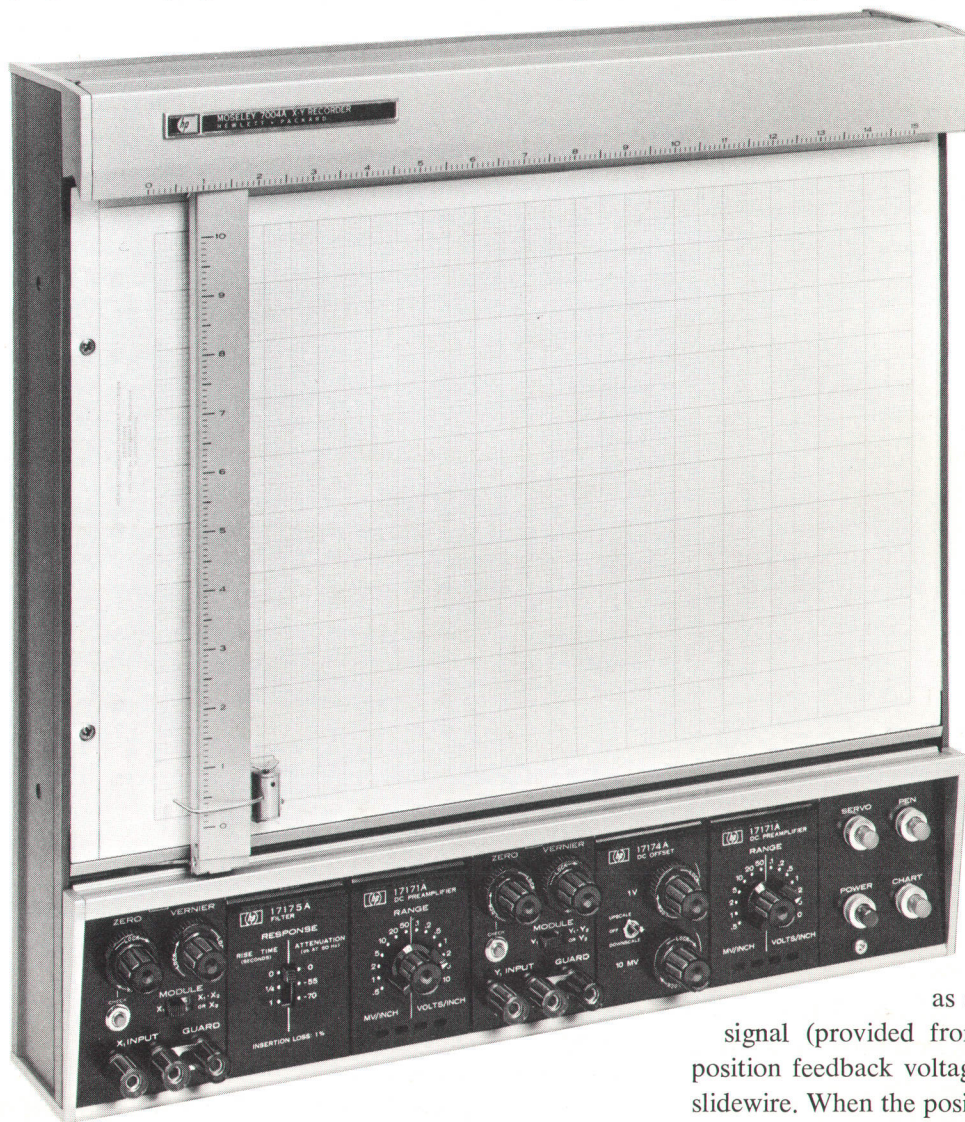

Fig. 1. Plug-ins are available for the new HP Model 7004A X-Y Recorder which provide flexibility to meet a variety of measurement applications.

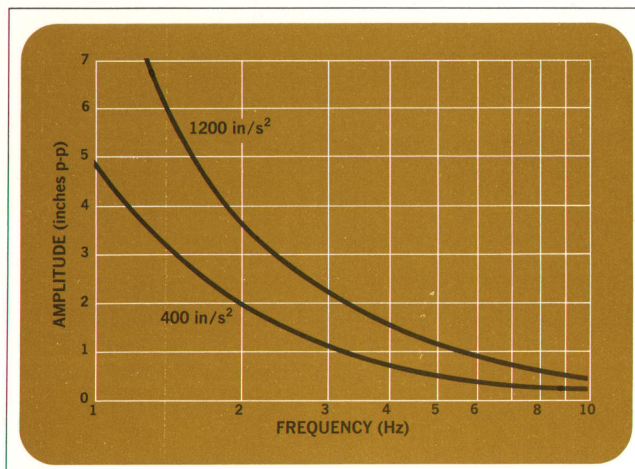

Fig. 2. Pen acceleration versus frequency. With a pen acceleration of 1200 in/s, the Model 7004A is capable of faithfully recording phenomena out to 10 Hz at an amplitude of about 0.4 inches.

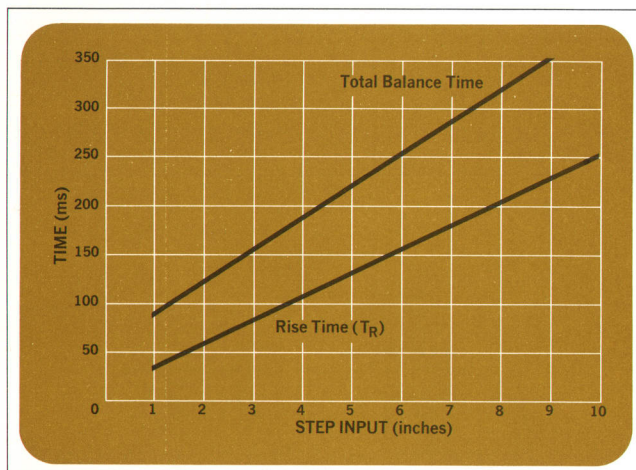



Fig. 3. Typical Y-axis response from a step input illustrates the relatively short time it takes for the pen to reach slewing speed.



Otto S. Talle, Jr.
 After graduating from UCLA in 1960 with a BSEE, Otto Talle joined the F. L. Moseley Co., now the Hewlett-Packard San Diego Division. He was project or group leader on the Models 7000A, 7004A, 7030A and 7035A X-Y Recorders. He was X-Y recorder group leader until mid-1968 when he became group leader for special X-Y and strip-chart recorders.

Otto holds a patent for a servo motor drive circuit.

Of most significance in the comparator is the lack of a resistive load at the slidewire wiper. Very small areas of contact resistance between the slidewire resistance element and the wiper commonly cause trace jitter. These elements of contact resistance are in series with the balance circuit and can cause an artificial error signal if their resistive values become a significant part (0.1%) of the balance circuit resistance. This condition causes the servo to bounce or jitter between apparent balance points. The balance circuit has the wiper feeding directly into the gate of a FET virtually eliminating the effect of the wiper contact resistance.

Stable input resistance is also important to the performance of such a recorder. In this case, the comparator operates as a differential amplifier, with the input signal going to one gate, the slidewire wiper to the other. As a result, no balance current flows through the signal circuit (current through the signal circuit is a typical fault of standard potentiometric circuits). Thus, under all balance or unbalance conditions, the input resistance is determined by the input shunt resistor which is a precise 1 Meg $\pm 0.1\%$. In cases where plug-ins with active circuitry are used, the input impedance is determined by the plug-in, and is independent of the balance condition.

To achieve the high dynamic performance of the Model 7004A, large surges of power are provided to the servo motor. Under normal operating conditions, the duty cycle is such that the rms power delivered to the motor will not cause a large temperature rise at the motor. However, with an excessively noisy input signal, with the recorder running against the stops for a prolonged time, and in some other circumstances, it would be possible to reach excessive motor temperatures. Therefore, the motor temperature is monitored and before it becomes excessive, the power to the motor is limited.

This decrease in power available to the motor is accomplished by a current limiter inside the amplifier feedback loop. When the current limiter is actuated, both the slewing speed and acceleration decrease. The servo dead-band is not affected by the limiting action.

Two functional blocks provide the plug-ins with sufficient information to control the recorder adequately and to accomplish proper interface with external systems. A typical application would be point plotting the output from an HP Multichannel Pulse Height Analyzer. The null sensing circuit provides the plug-ins with a signal that indicates an on null or off null condition. The mute circuit makes it possible to disconnect the servo motor remotely, so it will not respond to the input signal.

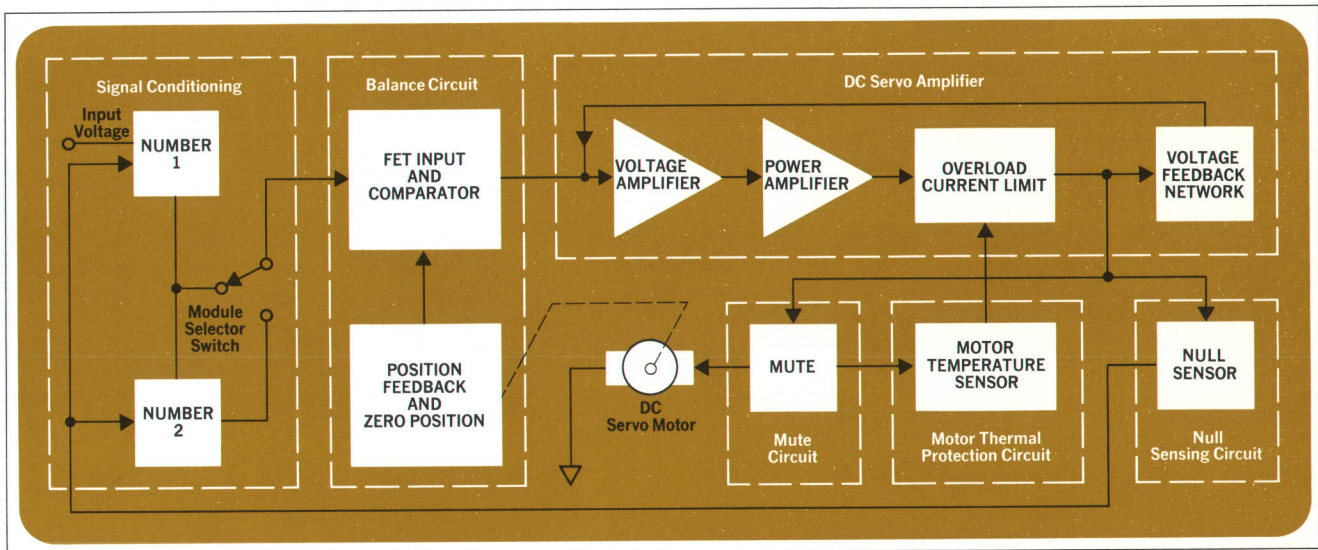



Fig. 4. Six functional blocks make up the Model 7004A main frame. Numbers 1 and 2 in the Signal Conditioning area are spaces for the plug-ins.

Acknowledgments

I would like to acknowledge the valuable contributions of the following people: Bill Wigand, Model 7004A main frame electronics and product design; Dick Kempin, mechanical and industrial design; Ken Slavin, me-

chanical design; Arnulv Straume and Ron Hatfield, motor design; Tom Vos, Model 17171A DC Preamplifier; Ron Norton, Model 17173A Null Detector; Tom Daniels, Model 17174A Offset, 17175A Filter and 17178A Attenuator; Henry Tardiff, Model 17172A Time Base; Bill Rempel, Model 17012B Point Plotter. 

SPECIFICATIONS

HP MODEL 7004A X-Y RECORDER 7004A Main Frame

NUMBER OF PLUG-INS: Frame will accept the equivalent of four single width plug-ins two per axis. Two filler panels are provided with each recorder main frame.

PLUG-IN SELECTOR: By use of a front panel switch the recorder may be set to use only X_1 and Y_1 position plug-ins. Alternately, it may be set to place X_1 and X_2 and/or Y_1 and Y_2 in series. The null detector is independent of these switches.

TYPE OF INPUT: Floated and guarded signal pair. Input may be operated up to ± 500 V dc with respect to chassis ground. Signal and guard terminals are available at the front panel or at a rear connector. Mating rear connector supplied.

STANDARDIZATION: Continuous electronic zener reference with temperature stability better than $0.002\%/^{\circ}\text{C}$.

ZERO SET: Zero may be placed anywhere on the writing area or electrically off scale up to 1 full scale from zero index. Adjustable by a locking ten-turn, high resolution control.

ZERO CHECK SWITCHES: A push button zero check switch in each axis allows verification of recorder's zero position without removal or shorting of the input signal.

RANGE VERNIER: Lockable continuously variable sensitivity control from maximum to 2.5 times basic sensitivity.

SLEWING SPEED: Greater than 30 in/s (75 cm/s) independent of line voltage and line frequency.

PEAK ACCELERATION: Greater than 1200 in/s² (3000 cm/s²).

STABILITY: Better than $0.003\%/^{\circ}\text{C}$ (includes reference stability).

TERMINAL BASED LINEARITY: $\pm 0.1\%$ of full scale.

RESETTABILITY: $\pm 0.05\%$ of full scale.

PAPER HOLDDOWN: Autogrip electric paper holddown grips charts 11 in x 17 in or smaller. Writing area 10 in x 15 in (25 cm x 38 cm). Special paper not required.

PEN LIFT: Electric pen lift capable of being remotely controlled.

DIMENSIONS: 17½ in (445 mm) wide, 17½ in (445 mm) high, 4¾ in (121 mm) deep.

WEIGHT: 24 lbs (10,9 kg) net, 32 lbs (14,5 kg) gross.

POWER: 115 or 230 volts ac $\pm 10\%$, 50 to 400 Hz, approx. 85 VA depending on the plug-ins used.

PRICE: Model 7004A, \$1295.00.

Plug-In Modules

17170A DC COUPLER
RANGE: 100 mV/in
SYSTEM ACCURACY: $\pm 0.1\%$ at full scale
PRICE: \$50.00

17171A DC PREAMPLIFIER
RANGE: 0.5 mV/in through 10 V/in
SYSTEM ACCURACY: $\pm 0.2\%$ of full scale
PRICE: \$250.00

17172A TIME BASE
RANGE: 0.5 to 100 s/in
SYSTEM ACCURACY: $\pm 1\%$ ($\pm 2.5\%$ on two slowest)
PRICE: \$200.00

17173A NULL DETECTOR
PLOTING RATE: Up to 50 points per second
SYSTEM ACCURACY: $\pm 0.25\%$ of full scale
PRICE: \$200.00

17174A DC OFFSET
OFFSET: 1 mV through 1 V
INSERTION LOSS: Less than 0.05%
PRICE: \$100.00

17175A FILTER
REJECTION: 50 and 70 dB at 50 Hz
INSERTION LOSS: 1%
PRICE: \$75.00

17178A DC ATTENUATOR
RANGE: 100 mV/in through 20 V/in
SYSTEM ACCURACY: $\pm 0.2\%$ of full scale
PRICE: \$100.00

MANUFACTURING DIVISION: SAN DIEGO DIVISION
16870 W. Bernardo Drive
San Diego, California 92127

A Low-Cost, General-Purpose Oscillator with Low Distortion and High Stability

By James M. Colwell and Paul F. Febvre

THE OSCILLATOR is still one of the most fundamental tools used in ac circuit design. Even though the basic techniques of designing oscillators have been well known for years, there is always a need for improved performance, especially in low-cost instruments. Measurements made on circuits are limited by the quality of the test signal. It has generally been assumed that only expensive oscillators can provide signals of purity and stability compatible with precision measurements. The effort reported here was to achieve such performance at more reasonable cost. The result is two newly-designed, low-cost oscillators, Fig. 1.

Output of the HP Model 204C is a sine wave from 5 Hz to 1.2 MHz in six overlapping bands. The amplitude is 5 V rms open circuit with a 600 ohm output impedance. The instrument can be line or battery operated. It can be powered from either mercury cells, or from

rechargeable nickel-cadmium batteries.

The HP Model 209A does not have battery operation, but delivers extended frequency range (4 Hz to 2 MHz), higher output voltage (10 V rms open circuit), and a square wave with 50 ns rise and fall time available simultaneously with the sine wave output.

One of the main advantages of the Models 204C and 209A is high signal purity. Total harmonic distortion approaches 70 dB below fundamental across most of the frequency range. At low frequencies, low distortion is usually obtained only with slow envelope response. In these oscillators, a rear panel switch allows the user to select either fast envelope response for rapid frequency sweeping or to select low distortion (down to the 60 dB area) with slower envelope response.

Flat Frequency Response

Except at very low and very high frequencies, the



Fig. 1. Small and lightweight, the Model 204C (left) uses interchangeable power supplies to allow operation either on ac power or batteries. Independent sine and square wave outputs are available from the Model 209A Sine/Square Oscillator (right).

oscillator output amplitude typically remains within 0.2% of any setting. The obvious advantage is that it practically eliminates the need for monitoring or resetting the input signal level for most frequency response tests. Signals of unusually low drift are produced.

Oscillators come in a small, rugged, lightweight package. The instrument can be disassembled quickly for easy maintenance. In the 204C, the 3-power supply options (line, Ni-Cad or mercury batteries) can be easily and quickly changed.

Circuit Description

The block diagram, Fig. 2, shows the classical configuration of a Wien bridge oscillator consisting of the Wien bridge with a variable resistor in the resistive side, a high gain amplifier, and a level detector controlling the variable resistor for AGC action. On the Model 209A, a buffer amplifier is used to provide the higher

output. The square wave circuit in the 209A consists of a tunnel diode for fast squaring of the sine wave and a saturating amplifier.

The redesigned Wien bridge uses a precision capacitive tuner of improved design. Because the rotor shaft electrically insulates the two sections of the tuner, circuit connections could be made to minimize stray capacities to ground and keep them constant. This allows for wide (12:1) tuning range and easy calibration despite the small size of the instrument.

The high gain amplifier has a FET input, is dc coupled throughout, and uses the Miller effect for shaping the amplifier roll-off. Taken together, these measures yield consistent open loop response from unit to unit. In addition, the circuit is insensitive to transistor aging, transistor replacement, and biasing is independent of power supply voltage within battery limits.

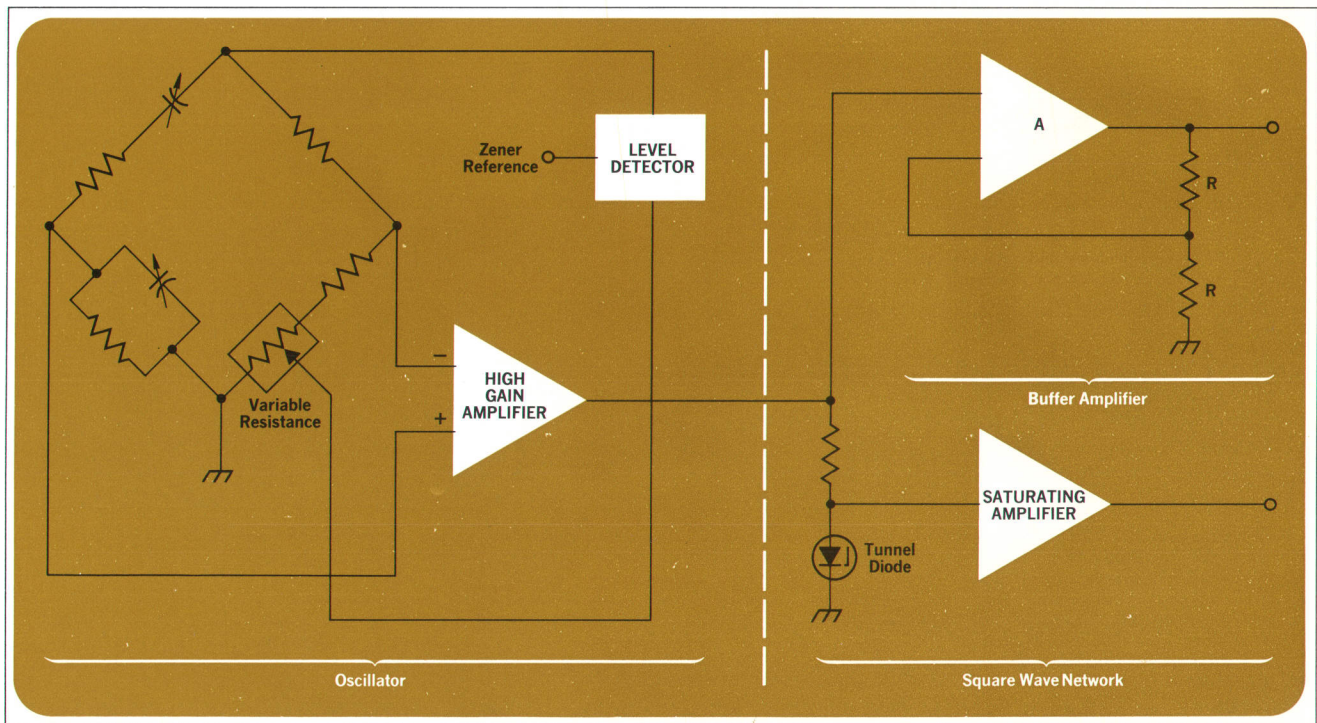

Fig. 2. A Wien bridge (left) is the heart of the two oscillators. Additional circuitry at the right amplifies the sine wave and also provides the square wave output of the Model 209A.

Amplitude Stability with a Zener Level Detector

A Wien bridge oscillator agc loop contains a level detector that controls a variable resistance on one leg of the bridge. These two elements can be separated or combined as one element such as a light bulb. A number of events can cause a Wien bridge to become unbalanced. These include change of load, temperature changes, or imprecise

tracking of the tuning capacitor when changing frequency. To restore balance, the variable resistance must be adjusted by the agc loop. To change the variable resistance, the control voltage must change.

In the conventional peak detector system, the control voltage is obtained by:

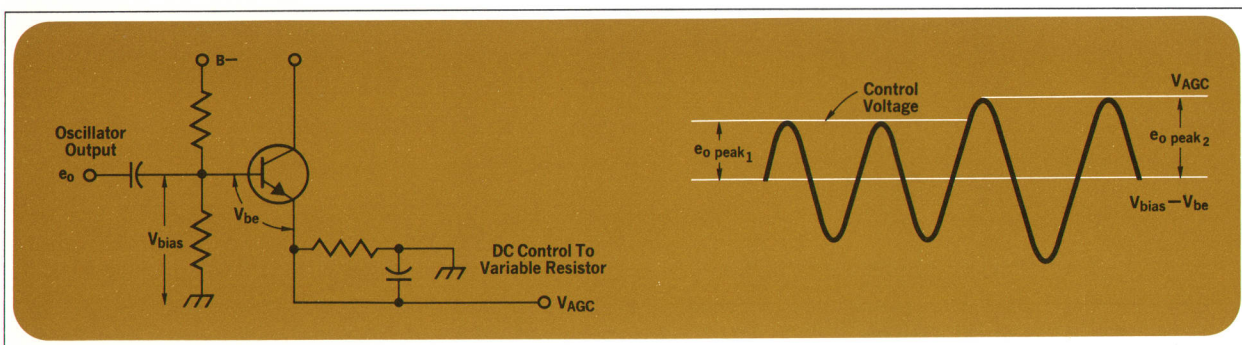

$$V_{agc} = e_o \text{ peak} + (V_{bias} - V_{be})$$

Note that to change control voltage, a change in e_o is required.

In the circuit, below, used in the Models 204C and 209A, the peak detector is biased from its own output.

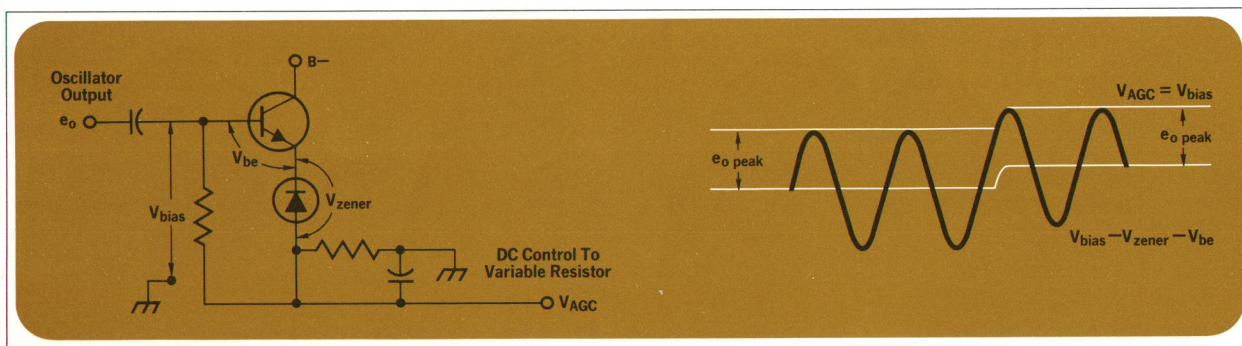

$$V_{agc} = e_o \text{ peak} + (V_{bias} - V_{zener} - V_{be})$$

and since

$$V_{agc} = V_{bias},$$

$$e_o \text{ peak} = V_{zener} + V_{be}$$

Oscillator level depends only upon zener voltage and V_{be} of the transistor. The zener is selected so its temperature

coefficient is opposite to that of V_{be} .

In the Models 204C and 209A, as a result of this circuit, typical 20-hour amplitude stability is $0.05\% + 0.05\%/C^\circ$, and typical frequency response is 0.2% .

Fig. 3. By molding a number of parts as part of the front panel (right) assembly time is reduced while increasing precision of positioning of a number of parts. The printed circuit board assembly (center) plugs into the front panel. Power supplies (left) plug into the main board. Standard $\frac{1}{3}$ module side frames lock the assemblies together.

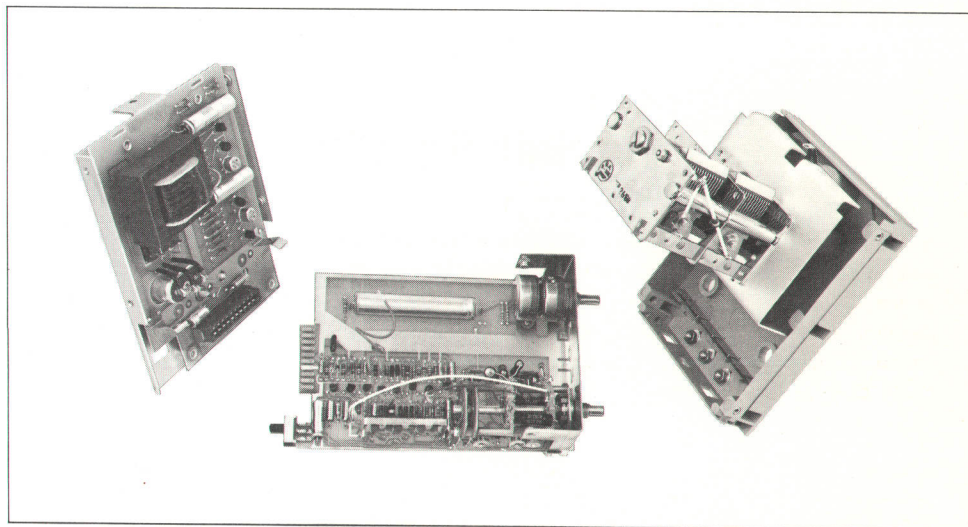

The variable resistive element used for the AGC is a FET with a linearizing feedback loop to minimize distortion. The level detector uses a special scheme to keep the amplitude extremely constant both with frequency and with time (see page 14).

Mechanical Layout

Much effort was made to improve and simplify the mechanical layout of the two new oscillators. Both mechanical and electrical accuracy were achieved while reducing assembly and test time and improving serviceability.

The 'backbone' of the instrument is its plastic front panel which serves as a simple and accurate mounting for the tuner, Fig. 3. It also incorporates many parts that are normally separate items which need to be fabricated and assembled such as: bail holder, binding post insulators, PC board guide, dial stop and cursor.

All but three assembly wires have been eliminated by using printed-circuit board connectors, board-mounted range switch and front panel controls. Assembly time is reduced and serviceability improved. Stray capacitances that are traditionally functions of lead dressing are reduced and are constant between units.

After calibration, instrument performance is checked automatically. The calibration and test time is cut by about half while reliability of the checking is improved.

Acknowledgments

The authors wish to thank Noel Pace, Bob Dudley and Ron Tuttle for their valuable assistance. Jim Crooks who worked on the product design, Bob Chambers who did the printed-circuit board layout and Ed Pennington who designed the front panel mold contributed greatly to the success of the project. 



James M. Colwell (right) joined Hewlett-Packard in Loveland in 1964 after receiving his BSEE from Purdue University. He received his MSEE from Colorado State University in 1967 on the HP Honors Cooperative Program.

Jim has been project leader on the Model 427A Multi-function Meter and the Model 11096A High-Frequency Probe. He worked on the circuit design of the Models 204C and 209A Oscillators, and is presently working in the Loveland integrated circuit group.

Paul F. Febvre (left) has a mechanical engineering degree from Ecole D'Arts et Metiers, Paris (1959) and received his MSEE from Colorado State University in 1963. He has also completed some graduate work towards a Ph.D. in physiology at CSU in the HP Honors Cooperative Program.

Paul joined HP at Loveland in 1964 and was design leader on the Model 3380A Electroanesthesia unit and the Model 3529A Magnetometer probe. He worked on circuit design and packaging on the Models 204C and 209A Oscillators.

SPECIFICATIONS

HP Model 204C Oscillator

RANGES

FREQUENCY: 5 Hz to 1.2 MHz in 6 overlapping ranges.

OUTPUT CHARACTERISTICS

OUTPUT VOLTAGE: 2.5 V rms (10 mW) into 600 Ω ; 5 V rms open circuit.

OUTPUT IMPEDANCE: 600 Ω .

OUTPUT CONTROL: >40 dB range, continuously adjustable.

OUTPUT BALANCE: >40 dB, below 20 kHz. Can be floated up to ± 500 V peak between output and chassis ground.

PERFORMANCE

DIAL ACCURACY: $\pm 3\%$ of frequency setting.

FLATNESS: At maximum output into 600 Ω resistive load 1 kHz reference):

Low Distortion Mode	$\pm 1\%$	$\pm 0.5\%$	$\pm 1\%$
Normal Mode	+5% to -1%	$\pm 0.5\%$	$\pm 1\%$

5 100 300k 1.2M
FREQUENCY — Hz

DISTORTION:

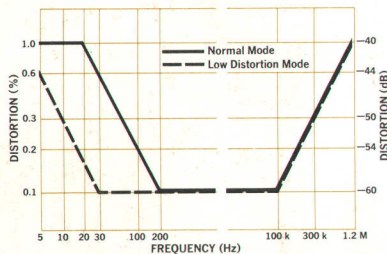

HUM AND NOISE: Less than 0.01% of output.

SYNCHRONIZATION

SYNC OUTPUT: Sine wave in phase with output; 1.7 V rms open circuit; impedance 10 k Ω .

SYNC INPUT: Oscillator can be synchronized to an external signal. Sync range, the difference between sync frequency and set frequency, is a linear function of sync voltage. $\pm 1\%/V$ rms for sine wave with a maximum input of ± 7 volts peak.

GENERAL

POWER: Standard: AC-Line 115 V or 230 V $\pm 10\%$, 50 Hz to 400 Hz, <4 W.

Opt. 01: Mercury batteries 300 hours operation.

Opt. 02: Line/Rechargeable batteries 115 V or 230 V $\pm 10\%$, 50 Hz to 400 Hz, <4 W.

35 hours operation per recharge.

WEIGHT: Net 6 lbs (2.7 kg).

PRICE: HP 204C (AC Line), \$250.

HP 204C Option 01 (Mercury batteries), \$265.

HP 204C Option 02 (Rechargeable batteries, AC-Line), \$285.

HP Model 209A Sine/Square Oscillator

RANGES

FREQUENCY: 4 Hz to 2 MHz in 6 ranges.

OUTPUT CHARACTERISTICS

SINE WAVE

OUTPUT VOLTAGE: 5 V rms (40 mW) into 600 Ω resistive 10 V open circuit

OUTPUT IMPEDANCE: 600 Ω .

OUTPUT CONTROL: 26 dB range, continuously adjustable.

OUTPUT BALANCE: >40 dB, below 20 kHz. Output can be floated up to ± 500 V peak between output and chassis ground.

SQUARE WAVE

OUTPUT VOLTAGE: 20 V peak-to-peak open circuit symmetrical about 0 V. Output can be floated up to ± 500 V peak.

RISE AND FALL TIME: <50 ns, into 600 Ω resistive load.

SYMMETRY: $\pm 5\%$.

OUTPUT IMPEDANCE: 600 $\pm 25\%$ depending upon setting of output control.

OUTPUT CONTROL: Continuously adjustable from zero to full output.

EXTERNAL SYNCHRONIZATION

SYNC OUTPUT: Sine wave in phase with output, 1.7 V rms open circuit; impedance 10 k Ω . (Frequency response at high frequencies is affected by capacitive loads.)

SYNC INPUT: Oscillator can be synchronized to external signal. For 5 V rms input, sync frequency can be as much as $\pm 7\%$ away from set frequency (sync range). Sync range is a linear function of sync voltage.

PERFORMANCE

DIAL ACCURACY: $\pm 3\%$ of frequency setting.

FLATNESS: At maximum output into 600 Ω resistive load, 1 kHz reference.

Low Distortion Mode	$\pm 1\%$	$\pm 0.5\%$	$\pm 1\%$	$\pm 5\%$
Normal Mode	+5% to -1%	$\pm 0.5\%$	$\pm 1\%$	$\pm 5\%$

4 100 300k 1M 2M
FREQUENCY — Hz

DISTORTION:

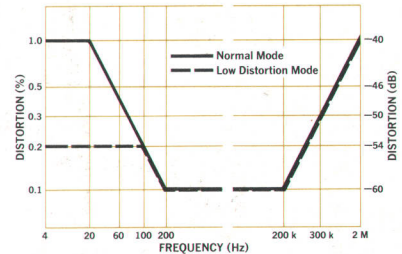

HUM AND NOISE: <0.01% of output.

GENERAL

POWER: AC-Line 115 V or 230 V $\pm 10\%$, 50 Hz to 400 Hz, <7 W.

WEIGHT: Net 6 lbs (2.7 kg)

ACCESSORIES AVAILABLE:

HP 11075A Instrument Case, \$45.00.

PRICE: HP 209A, \$320.00.

MANUFACTURING DIVISION: LOVELAND DIVISION

P.O. Box 301
815 Fourteenth St. S.W.
Loveland, Colorado 80537